

Flamingo coll.ne DESIGN

Completamente sfoderabile

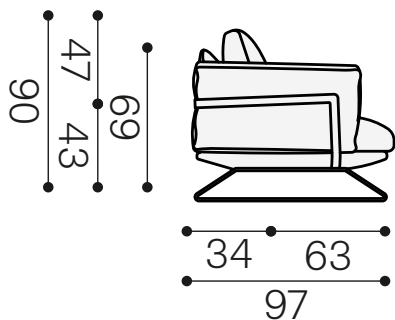

Divani fissi

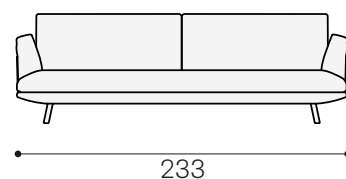
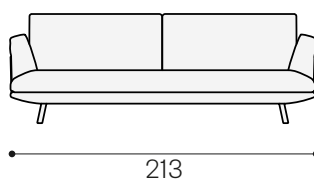
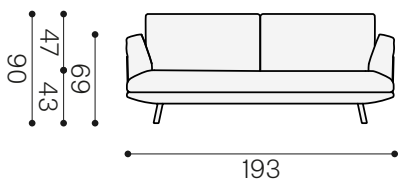

Elementi laterali

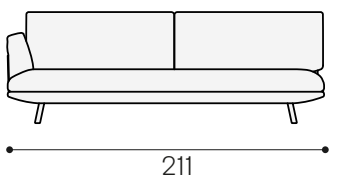
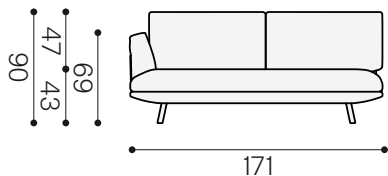

Penisola

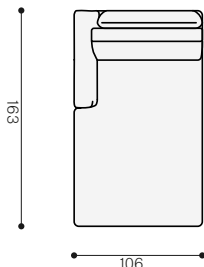

Dormeuse

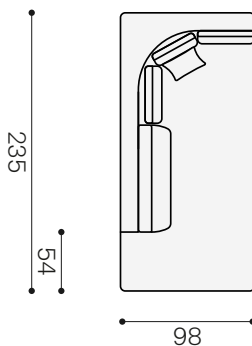

Pouf

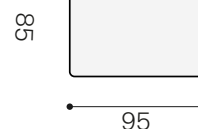

caratteristiche tecniche

- struttura In legno massello e agglomerato rivestito in poliuretano espanso e vellutino accoppiato.
- seduta In poliuretano espanso indeformabile e fibra di poliestere
- schienale In mistopiuma con camere separate e rivestite in tela di cotone
- braccioli In poliuretano espanso indeformabile e fibra di poliestere
- versioni Non componibile - componibile - senza letto

100% MADE IN ITALY

pedini disponibili

1 Piede SPICA
finitura: verniciato moka
H. 18 cm

2 Piede MAIA
finitura: verniciato antracite
H. 18 cm

