

Completamente sfoderabile
PROFONDITA' CM.80

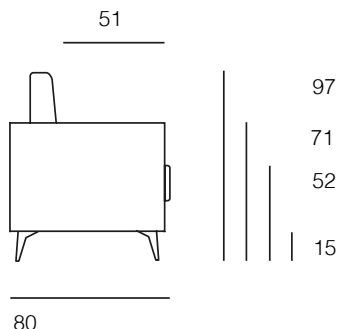

POLTRONA

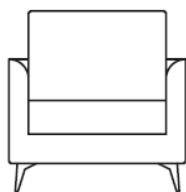

95

DIVANO 2 POSTI

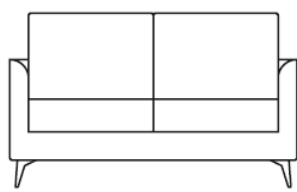

160

DIVANO 3 POSTI

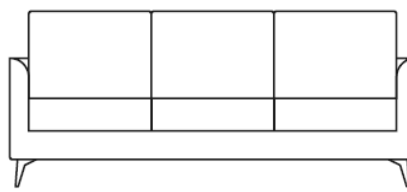

225

LATERALE 1 POSTO

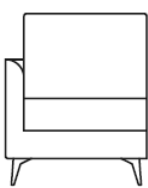

80

LATERALE 2 POSTI

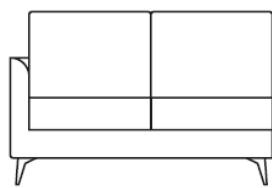

145

LATERALE 3 POSTI

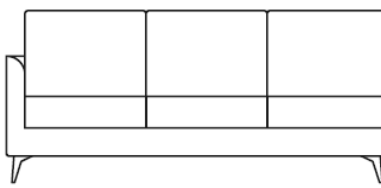

210

ANGOLO CHIUSO

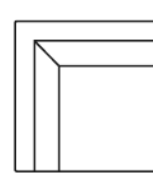

80x80

ANGOLO CON LATERALE 2 POSTI
 DX/SX

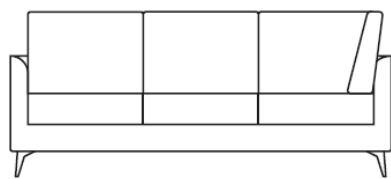

225

145

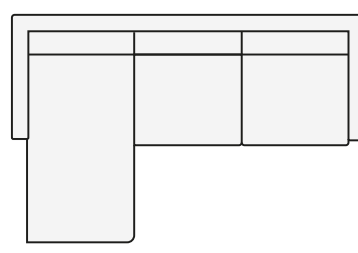

225

Composizione DIVANO 3P GRANDE CON
 POUFF PENISOLA REVERSIBILE

POUF



83x83

caratteristiche tecniche

struttura	In agglomerato di legno e masselli d'abete rivestito in espanso da 8 mm e vellutino accoppiato. Fondo a cinghie elastiche intrecciate
seduta	In poliuretano espanso indeformabile e fibra di poliestere con rivestimento in tela di cotone
schienale	in fibra di poliestere
braccioli	in poliestere espanso e fibra di poliestere
versioni	NON componibile - componibile - SENZA letto